



FR30
TOUCH



RAPID30
TOUCH

EN Use and Maintenance

CE

49.0261.00
ed. 02/2022

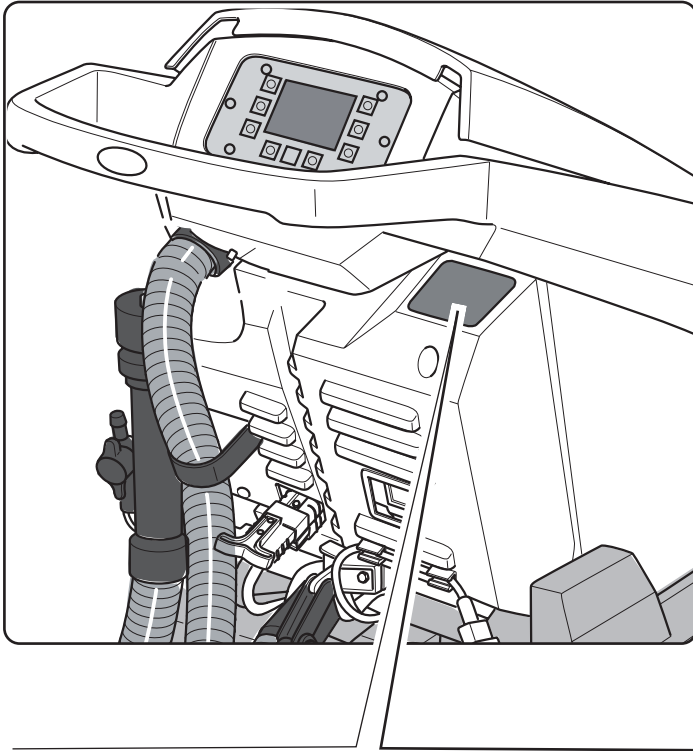

1 — [Label for a rectangular area on the rear panel]

2 — [Label for the technical specifications section]

3 — [Label for the serial number (Nr.)]

4 — [Label for the IP rating]

5 — [Label for the gross weight (GVW)]

6 — [Label for the year of manufacture]

7 — [Label for the article number (Art.)]

8 — [Label for the model number (Mod.)]

Scrubber Dryer



Battery mode: V - W

Charging mode: ... - ... V ~ ... / ... Hz ...W

Nr. **IP:** **GVW:** Kg

MADE IN ITALY **Year:** **MAX 2%**

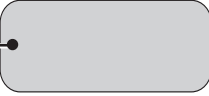
Mod: **Art.:**

	1	2	3	4
IT	Produttore	Caratteristiche elettriche	N° Matricola	Grado di protezione
EN	Manufacturer	Electrical characteristics	Serial N°	Degree of protection
FR	Producteur	Caractéristiques électriques	N° Matricule	Degré de protection
DE	Hersteller	Elektrische Eigenschaften	Matrikelnr.	Schutzgrad
ES	Fabricante	Características eléctricas	N° Matricola	Grado de protección
PT	Produtor	Características elétricas	Número de série	Grau de protecção
NL	Producent	Elektrische eigenschappen	Serienummer	Beschermingsgraad
CS	Výrobce	Elektrické údaje	Výrobní č.	Úroveň ochrany
RU	Изготовитель	Электрические характеристики	Заводской №	Степень защиты
PL	Producent	Właściwości elektryczne	Nr. Fabryczny	Stopień ochrony
AR	الصانع	المواصفات الكهربائية	الرقم التسلسلي	درجة الحماية

	5	6	7	8
IT	Peso in ordine di marcia	Anno di costruzione	Codice articolo	Modello
EN	Weight in running order	Year of manufacture	Item code	Model
FR	Poids en ordre de marche	Année de construction	Référence de l'article	Modèle
DE	Gewicht bei Betrieb	Baujahr	Artikelnummer	Modell
ES	Peso en orden de marcha	Año de fabricación	Código del artículo	Modelo
PT	Peso em ordem de marcha	Ano de construção	Código do artigo	Modelo
NL	Gewicht in rijklare toestand	Bouwjaar	Artikelcode	Model
CS	Hmotnost v provozním stavu	Rok výroby	Kód položky	Model
RU	Эксплуатационный вес	Год выпуска	Код изделия	Модель
PL	Ciężar w stanie pracy	Rok produkcji	Kod produktu	Model
AR	الوزن في وضعية التشغيل	سنة الصنع	رمز المنتج	الطرز



English ENGLISH - 1
(Translation of original instructions)

*Dear Customer,
Thank you for choosing one of our cleaning products.*



The floor scrubber dryer that you have purchased has been designed to satisfy the user in terms of ease of use and reliability over time.

We are aware that in order for a good product to stay that way, over time, it requires continuous updates aimed at meeting the expectations of those who use it on a daily basis. For this reason, we hope that you will not only be a satisfied customer but also a partner who does not hesitate to give us your opinions and ideas originating from your personal day-to-day experience.

Contents

Technical data	EN-3
1.1 Introduction	EN-5
2.1 Getting to know the machine	EN-5
3.1 Unpacking	EN-5
3.1.a Standard machine equipment	EN-5
4.1 Assembling the components	EN-5
4.1.a Wiper assembly.....	EN-5
4.1.b Brush assembly.....	EN-5
4.1.c Installing and connecting the batteries	EN-6
5.1 Charging the battery	EN-6
5.1.a Charging the battery using the on board battery charger (if present)	EN-6
5.1.b Charging the battery using an external battery charge	EN-7
6.1 Control panel	EN-7
6.2 Working cycle example	EN-8
7.0 Safety password	EN-9
7.1 Parameter setting	EN-9
7.1.a Language setting.....	EN-10
7.1.b Battery type setting.....	EN-10
7.1.c Brightness and contrast setting	EN-10
8.1 Display	EN-10
9.1 Filling the tank	EN-11
10.1 Operation	EN-11
10.1.a Checks before use	EN-11
10.1.b Preparing the machine and choosing the cycle	EN-12
10.1.c Using the machine	EN-12
10.1.d End of use and switching off	EN-13
10.1.e Maximum recovery tank water level alarm.....	EN-13
10.1.f Alarms list	EN-14
11.1 Draining the recovery water	EN-15
12.1 Maintenance and cleaning	EN-15
12.1.a Emptying and cleaning the clean water tank	EN-15
12.1.b Cleaning the recovery water tank	EN-16
12.1.c Cleaning the squeegee	EN-16
12.1.d Cleaning the clean water filter.....	EN-16
12.1.e Replacing the brush	EN-17
12.1.f Replacing the squeegee rubber blades	EN-17
12.1.g Cleaning the recovery water tank	EN-17
12.1.h Replacing the fuses	EN-17
12.1.i Wiper adjustment	EN-18
12.1.l Battery charger and digital instrument configuration.....	EN-18
Troubleshooting	EN-19
13.1 Warranty	EN-20
Wiring diagram	EN-21

Technical data

	30M45	30D45	30D50
Type of use	Operator on ground		
Characteristics			
Power supply	Battery	Battery	Battery
Power supply voltage	See technical data plate		
Installed load	750 W	930 W	1030 W
Forward movement	Manual	Tractioned	Tractioned
Washing width *	430 mm	430 mm	500 mm
Drying width	650 mm	650 mm	650 mm
Theoretical hourly working capacity	1720 m ² /h	1935 m ² /h	2250 m ² /h
Brushes / Pad			
Diameter / Number	430mm/17"x1	430mm/17"x1	250mm/10"x2
Motor power / number	350 Wx1	350 Wx1	450 Wx1
Motor speed	190 giri/min.	190 giri/min.	200 giri/min.
Specific pressure	33 gr/cm ²	33 gr/cm ²	33 gr/cm ²
Aspiration			
Motor power	400 W	400 W	400 W
Negative pressure	1189 mmH ₂ O	1189 mmH ₂ O	1189 mmH ₂ O
Air flow rate	28 l / sec	28 l / sec	28 l / sec
Noise level	Min. 58 dB (A)  / Max. 64 dB (A) 		
Traction			
Engine power	---	180 W	180 W
Tank			
Recirculation	No	No	No
Solution capacity	30 l	30 l	30 l
Recovery capacity	33 l	33 l	33 l
Dimensions (lxwxh) without wiper	1210 x 560 x 1020 mm	1210 x 560 x 1020 mm	1100 x 570 x 1020 mm
Vibrations ISO 5349 m/sec²	< 2,5	< 2,5	< 2,5
Weight			
Empty weight	68 Kg	74 Kg	76 Kg
Weight with batteries	121 Kg	127 Kg	129 Kg
Weight in running order GVW	151 Kg	157 Kg	159 Kg

* The washing width is intended with the machine operating and the brush pressed down.

	30M45	30D45	30D50
Accessories			
0.7 ø PPL brush	40.0002.00 POLY 0,7	40.0002.00 POLY 0,7	40.0010.00 POLY 0,7
Brush spray guard	24.0237.00	24.0237.00	24.0261.00
Front rubber wiper element	39.0129.00	39.0129.00	39.0129.00
Rear rubber wiper element	39.0130.00	39.0130.00	39.0130.00
Optional accessories			
0.9 ø PPL strong brush	40.0102.00 POLY 0,9	40.0102.00 POLY 0,9	40.0110.00 POLY 0,9
1.2 ø grit 80 tynex brush	40.0202.00	40.0202.00	40.0210.00
Drive mechanism	40.1007.00	40.1007.00	40.1110.00
Front anti-oil rubber wiper element	39.0131.00	39.0131.00	39.0131.00
Rear anti-oil rubber wiper element	39.0132.00	39.0132.00	39.0132.00

1.1 INTRODUCTION



DANGER:

Before using the machine, carefully read the attached "SAFETY WARNINGS FOR THE FLOOR SCRUBBER DRYER" manual.

2.1 GETTING TO KNOW THE MACHINE (Fig. 1)

- 1) Guide handle.
- 2) Control console.
- 3) Squeegee activation lever.
- 4) Water supply tap.
- 5) Solution tank.
- 6) Tank cover.
- 7) Clean water filling opening.
- 8) Wheels.
- 9) Brush rotation flange.
- 10) Brush.
- 11) Squeegee.
- 12) Recovery water drain hose.
- 13) Squeegee water aspiration hose.
- 14) Recovery water tank.
- 15) Clean water drain/level tube.
- 16) Water filter.
- 17) Clean water filter.
- 18) Brush up/down pedal.
- 19) Brush rotation activation button.
- 20) Touch sensor for starting traction and brush rotation.

3.1 UNPACKING (Figg. 1-2)

Once the packaging has been removed as shown in the instructions on the packaging itself, check that the machine and all the components supplied are intact.

If any evident damage is found, contact the area agent and the carrier within 3 days of receipt.

- Remove the bag (21) containing the accessories.
- Cut the strap (22).
- Remove the wooden blocks (23 and 24).
- Lift the brush flange (9) by pressing down on the pedal (19) (see relative para-

graph).

- Lift the wiper support (25) by lifting the handle (3 Fig. 1) (see relative paragraph).
- Position a chute and unload the machine from the bench.

3.1.a - Standard machine equipment (Fig. 3)

The accessories supplied are as follows:

- 10) Brush/brushes.
- 11) Wiper.
- 26) Water filling hose.
- 27) Machine use and maintenance manual.
- 28) Battery charger instruction manual (if present).
- 29) Battery charger power cable (if present).
- 30) 5A fuse.
- 31) Filter for clean water tank opening.

4.1 ASSEMBLING THE COMPONENTS

4.1.a - Wiper assembly (Fig. 4)

- Loosen the two handwheels (32) located on the wiper (11).
- Assemble the wiper (11) on the support (25), tightening the two handwheels (32).
- Connect the tube (13) to the wiper connector (33).



N.B.:

Perform the previous operations with the wiper support lowered.

4.1.b - Brush assembly (Fig. 5)



HAZARD:

Operation to be performed by two people!

- Lift the brush rotation flange (9) slightly and remove the polystyrene protection (34).
- Assemble the brush as described in the paragraph "replacing the brush".

4.1.c - Installing and connecting the batteries (Fig. 6)



WARNING:

CHECK THAT THE RECOVERY TANK AND THE CLEAN WATER TANK ARE EMPTY.

- Disconnect the plug (35).
- Press the button (36) and lift the tank (14) until completely overturned.
- Position the batteries (37) as shown in the figure and connect them as shown on the chart in Fig. 6 using the cables supplied.
- Tighten the terminals (38) using an insulated wrench.
- Lower the tank (14) until a coupling "click" is heard.
- Connect the plug (35) to the relevant socket (39).



N.B.:

The battery must be connected by specialised personnel.

5.1 CHARGING THE BATTERY



DANGER:

Charge the batteries in rooms which are well-ventilated and comply with applicable regulations in the country of use. For safety-related information, follow what is described in chapter 1 of this manual.



WARNING:

For information and warnings about the battery and on board battery charger (if present) follow what is described in the battery charger manual enclosed with this document.



WARNING:

When the machine leaves the factory, it is calibrated to operate with gel batteries. If other types of batteries are installed, see the paragraph "Parameter setting". The use of gel batteries with calibration for acid or other batteries is prohibited.



NOTE:

10 hours are needed for complete battery charging. Avoid partial recharges.

5.1.a - Charging the battery using the on board battery charger (if present) (Fig. 7)

- Move the machine close to a mains electricity socket.



WARNING:

It is important to first connect the cable (41) to the socket (42) and then connect the cable (41) to the power socket.

- Take the cable (41) from its seat and connect it to the socket (42) on the machine, then connect the other end to the mains power socket.
- Check that the green LED (43) flashes 2 times and then goes from the color "Green" to continuously lit "Red".



WARNING:

Make sure that the mains electrical voltage is compatible with the battery charger's operating voltage (230 Vac for the European market; 115 Vac for the American market; 50/60 Hz).

- Leave the batteries to charge until the "Green" LED (43) lights up, then remove the power cable (41) and put it away.

5.1.b - Charging the battery using an external battery charger (Fig. 8)



WARNING:

It is important to first connect the plug (35) to the socket (44) of the battery charger and then connect the battery charger to the mains socket, otherwise the batteries will not charge.

- Move the machine close to the battery charging station.
- Remove the battery plug (35) from the system socket (39).
- Connect the battery plug (35) to the external battery charger socket (44).
- Once battery charging is complete, reconnect the battery plug (35) to the system socket (39).

6.1 CONTROL PANEL (Fig. 9)





WARNING:

Before using the machine you must select the washing cycle as shown in the relevant paragraph.

20) Sensor for starting the traction and brush rotation **• (for model with traction)**

Check the display so that the minimum traction speed is set.



By operating the sensor (20) with the button (45) “”, the button (52) “

” and the button (51) “” pressed, the traction and brush rotation will start and also the water supply.

The machine automatically starts in forward motion; press and hold down button (48) “” while also using sensor (20), the machine starts in reverse.

To move in reverse, lift the wiper.

20) Sensor for starting brush/es rotation **• (for model with traction)**

By operating the sensor (20) with the button (45) “”, the button (52) “

” and the button (51) “” pressed, the traction and brush/es rotation and water supply will start.

45) Main switch “”

By pressing the button, voltage is inserted in the circuits allowing the operation of commands and of the appropriate buttons; the display (46) will turn on. Press the button again to disconnect the voltage from the circuits.

46) Display

It lights up after the voltage is supplied to the circuits using the button (45) “”.

The display indicates the machine status, battery charge, working hours (for model with traction) and alarm messages.

47) Speed control buttons (for model with traction only)

Button (47a) “”.

Pressed, increases the traction speed.

Button (47b) “”.

Pressed, decreases the traction speed.

The display (46) indicates the set speed.



48) Reverse button “” (for model with traction only)

Check the display so that the minimum traction speed is set.

Pressed and held down while operating the sensor (20), the machine will start to go backwards towards the operator. The display will show the following symbol “”.



50) Aspirator start button “”



Button operation is enabled by pressing the button (45) “”.

Press the button (50) “”, the aspirator will start to function; the symbol “” appears on the display.

To turn off the aspirator, press the button (50), the turbine will continue to function for a few seconds in order to aspirate the liquid on the floor, afterwards it will turn off automatically. The symbol “” will disappear from the display

49) Silent operation button “”



Pressing the button (49) “” reduces the speed of the intake turbine, which considerably reduces the machine noise ; the symbol “” appears on the display with the function enabled.



Pressing again button (49) “” turns off the function and the machine will start to operate again in standard mode; symbol “” appears on the display.

**NOTE:**

When turning off the aspiration turbine with “silent operation” mode enabled, the operation of the turbine will automatically switch to “standard operation” mode for the entire shut-off delay time.

51) Water solenoid valve button “”

Button operation is enabled by pressing the button (45) “” and button (52) “”.



Press the button (51) “”, the display will show the symbol “”, and the opening of the water solenoid is being prepared. Its operation is controlled by the sensor (20).

The water quantity can be adjusted using the tap (4).

To stop water dispensing, press the button (51) “”.

52) Brush rotation enable button “”

Button operation is enabled by pressing the button (45) “”.

Press the button (52) “”, and the brush rotation will be activated; the display will show the symbol “”. Brush/es operation is controlled by the sensor (20).

To stop brush rotation, press the button (52) “”.

4) Water quantity adjustment tap

- Turn the tap (4) counter-clockwise to increase the quantity of water or turn it clockwise to decrease it.

6.2 WORKING CYCLE EX-AMPLE (Fig. 9)

Setting a washing cycle with brushes and drying.

- Press the button (51) to allow the water supply.
- Press the button (52) to allow brush rotation.
- Press the button (50) and the vacuum will start.

**NOTE:**

In special environments it is possible to activate the noise reduction function by pressing the button (49).

**WARNING:**

When turned on, be careful not to touch the touch sensor (20); the machine triggers an alarm and the “” symbol flashes on the display.

If you release the sensor within two seconds, the alarm will automatically turn off and after more than two seconds you will need to stop and restart the machine.

- Select the desired speed by pressing the buttons (47a) or (47b) (only for the model equipped with traction).



NOTE:

It is possible to change the speed even during the working cycle, with the machine in motion by acting the appropriate buttons.

- Gently touch the touch (20) button and the machine will start the selected program and the working cycle.



NOTE:

It is possible to change the working cycle depending on the work requirements. In order to change the cycle you must stop the machine, select a new cycle and activate the cycle by pressing the touch button (20).

7.0 SAFETY PASSWORD

The machine can be equipped with a safety passwords; for enabling it or disabling it, please contact technical support. If the password was enabled, in order to enter the numbers follow the instructions on the display.

The password will remain active for 75 minutes after having it switched off or after the last use; if you want to re-enable the introduction of the password proceed as follows: Turn off the machine, unplug the battery connector (35 Fig. 8) for a few seconds and then reconnect it.



When the machine is turned on again it will require a password.

7.1 PARAMETER SETTING (Fig. 9)

The operator can access the menu to set the following parameters:

- Language;**
- Battery type;**
- Brightness / contrast.**

Proceed as follows to access the menu:

- Press and hold down (47b) and (52) “”, then press the power button (45) “” to start the machine until you see the following display:



- Release the pressed keys.
- Enter the passwords by pressing the keys (47a) (47b) until the display shows the number “10”.
- Press the button (51) “” to confirm the password and enter the parameter setting menu; the following screen appears:



- To browse the parameter setting menu, press the button (52) “” and the following screens will appear in succession:

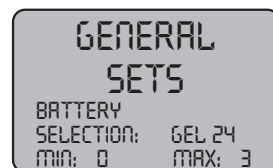



7.1.a - Language setting

- Enter the parameter setting menu until the following screen appears:



- Select the language (47a) and (47b), then press the buttons (51) “” to confirm your selection.

7.1.b - Battery type setting

- Enter the parameter setting menu until the following screen appears:



- Select the battery type by using the buttons (47a) and (47b), then press the button (51) “” to confirm your selection;

GEL = Gel battery
AGM = AGM battery
WET = ACID battery

7.1.c - Brightness and contrast setting

- Enter the parameter setting menu until the following screen appears:



- Set the display brightness by selecting a value from “0 to 10” with the buttons (47a) and (47b), then press the button “” to go to the contrast settings.



- Set the display contrast by selecting a value from “5 to 50” with the buttons (47a) and (47b), then press the button (51) “” to confirm your selection.

8.1 DISPLAY (Fig. 10)



The following pictograms appear on the display:

“A”  = Battery
Indicates the battery charge status;

“A1”  = battery charged;

“A2”  = battery discharged.



 = traction speed (if present)

The movement speed can be changed from “0” to the maximum speed in 5 steps, using buttons “” and “” to increase or decrease the speed.

 = reverse (if present)



This appears on the display when selecting the button  and a reverse operation is performed; when the button is released the pictogram disappears.

 = Aspirator operating



This appears on the display when selecting the button  indicating that the aspirator is operating; when repressing the button  to stop operation, the pictogram will flash for a few seconds and disappears when the aspirator stops.

 = Silent operation



Vacuum in operation.

This appears on the display when selecting the button  indicating that the aspirator is operating at a reduced speed; when repressing the button  to return to normal operation the pictogram disappears.

 = Water dispensing presetting

This appears on the display when selecting the button  indicating that the water dispensing solenoid valve is enabled; when repressing the button  solenoid valve operation is disabled and the pictogram disappears.

 = Brush rotation presetting

This appears on the display when selecting the button  indicating that brush rotation is enabled; when repressing the button  brush rotation motor operation is disabled and the pictogram disappears.

 = Maximum fluid level in the tank

This displays when the fluid in the recovery tank has reached the maximum level.

9.1 FILLING THE TANK (Fig. 11)



WARNING:

Only add clean mains water to the tank at a temperature no greater than 50°C.

- Remove the hose (26) supplied, connect one end (26a) to a tap and insert the other end (26b) in the tank (5).
- Check that the tap (53) is open.
- Turn on the tap and fill the tank (5).
- The level of water contained in the tank is displayed on the transparent tube (15).
- Pour the detergent fluid in the tank.



NOTE:

Use non-foamy detergents only. For the quantities, follow the instructions provided by the detergent manufacturer according to the type of dirt.



DANGER:

If the detergent comes in contact with the eyes and/or skin or if swallowed, refer to the use and safety information booklet provided by the manufacturer of the detergent.

10.1 OPERATION (Fig. 1)

10.1.a - Checks before use

- Check that the exhaust tube (12) of the recovery tank is properly coupled and properly sealed.
- Check that the connector (54) on the squeegee (11) is not blocked and that the hose is connected correctly.
- Check that the clean water exhaust tube (15) is correctly coupled to the supports and that the tap (53) is open.
- Press the button (45) and check the battery charge state on the display.

10.1.b - Preparing the machine and choosing the cycle (Fig. 9-12)

- Press the button (45 Fig.9), the display (46 Fig.9) lights up, indicating the battery charge status.
- Release the lever (3 Fig. 12) and lower it; the floor squeegee (11 Fig. 12) is lowered.
- Press the pedal (19 Fig. 12), disengage it from its lodging and lift it: the brush/brushes (10 Fig. 12) will be lowered.

Working cycle:

- The machine can perform 4 working cycles:

Drying only cycle:

- To perform only the drying cycle, press the button (50 Fig. 9), the aspirator will start.
Use the appropriate controls to activate the drive mechanism, if available for the model in use.

Brushing only cycle:

- To perform only the brushing cycle, press the button (52 Fig. 9) to enable brush rotation.
Press the control located on the handle to start brush rotation (traction will also start in models with integrated traction).

Washing, brushing cycle:

- Press the button (52 Fig. 9) to enable brush rotation, press the button (51 Fig. 9) to enable water dispensing.
Press the control located on the handle to start brush rotation and/or water dispensing (traction will also start in models with integrated traction).

Washing, brushing, drying cycle:

- Press the button (50 Fig. 9) to start the aspirator, button (52 Fig. 9) to enable brush rotation and press the button (51 Fig. 9) to enable water dispensing.
Press the control located on the handle to start brush rotation and/or water dispensing (traction will also start in models with integrated traction).

10.1.c - Using the machine (Fig. 1)

- After starting the machine and selecting the type of the cycle, start the cleaning operations by pushing the machine using the handle (1 Fig. 1) or operating the sensor (20 Fig. 1) for starting the traction (for models equipped with this).



NOTE:

Pay attention to particularly delicate floors: do not use the machine while it's stopped and the brush rotation on.

For particularly dirty spots, adjust the traction speed to "0" so the brush will rotate in the same position, without straining the traction motor.



NOTE:

The proper cleaning and drying of the floor is done by pushing the machine forwards: if you go backwards the machine will not perform drying; in this phase, always lift the wiper to avoid damaging the blades.

- Adjust the traction speed (if present) as shown above.
- If necessary, adjust the quantity of washing water using the tap (4 Fig. 1).
- Check the battery charge status on the display.

10.1.f - Alarms list (Fig. 9)

If the machine malfunctions, the display (46) will indicate the alarm type, according to the following list.

In order to restore the machine's proper functionality, consult the list below and perform the recommended procedures.

If the recommended actions should not resolve the problem, contact Technical Assistance.

Alarm	Meaning	Solution
AL_1: Function Brush Amp.	Brush amperometric protection	Check the brush operating mode. High brush motor working current detected.
AL_2: Function Aspirator Amp.	Aspirator amperometric protection	Check aspirator motor absorption. High aspirator motor working current detected.
AL_3: Function Power failure	Power stage damaged	Damaged aspirator or brush power stage: replace card.
AL_4: Function Overcurrent	Overcurrent on brush or aspirator outputs	Short circuit detected on brush or aspirator motor output: check connections and motor state.
AL_5: Function Overtemperature	Thermal protection on brush/aspirator stage	Brush and aspirator power stage overheating: check absorption.
AL_15: Traction Overtemperature	Thermal protection on traction stage	Traction power stage overheating: check absorption.
AL_16: Traction Power failure	Traction power stage damaged	Damaged traction power stage: replace card.
AL_17: Traction Overcurrent	Overcurrent on traction output	Short circuit detected on traction motor output: check connections and motor state.
AL_18: Traction Traction Amp.	Traction amperometric protection	Check the traction operating mode. High traction motor working current detected.
AL_20: General EEprom failure	Inner memory card error	Replace card.
AL_22: General Main relay	Main relay damaged	The main relay on the card appears damaged: replace the card.
AL_23: General Overvoltage	Overvoltage	Overvoltage on function card detected. Check the battery connections.

Alarm	Meaning	Solution
AL_24: Traction Batt Connection	Battery not connected to the function card	Check the traction operating mode. High traction motor working current detected.
AL_25: General Key connection	No control panel-function communication	Check connections between the keypad card and functions.

11.1 DRAINING THE RECOVERY WATER (Fig. 15)

At the end of the washing cycle or when the recovery water tank (14) is full, it is necessary to empty the tank by proceeding as follows:



NOTE:

To dispose of the recovery water, comply with the standards in force in the country in which the machine is used.

- Position the machine near to a drain outlet.
- Disconnect the hose (12) from the support.
- Remove the cap (56) from the hose (12) and drain all the water contained in the tank.



NOTE:

The amount of water that comes out can be modulated by pressing on the end of the tube (12).

- Put the cap (56) back on the hose (12) and reposition it on the relative support.

12.1 MAINTENANCE AND CLEANING



WARNING:

All maintenance operations must be performed with the machine off and tanks empty.

OPERATIONS TO PERFORM DAILY

12.1.a - Emptying and cleaning the clean water tank (Fig. 16)



WARNING:

At the end of the washing operations, it is compulsory to drain and clean the clean water tank (5) to prevent deposits or scaling.

After draining the recovery water tank, drain the clean water tank as follows:

- Position the machine over a drain outlet.
- Disconnect the tube (15) from the hooks, close the tap (53), lower the tube to the ground on the drain outlet, open the tap

(53) and let the water drain completely.

- Wash the inside of the tank, leaving the drain hose open and adding clean water through the top opening.
- When cleaning is complete, lift the tube (15), leaving the tap (53) open; couple the tube in its recesses.
- To completely drain the water from the tank (5) disconnect the tube (57) from the quick connector (58) then turn the connector downwards, letting the water drain completely; or remove the filter cover (59).

12.1.b - Cleaning the recovery water tank (Fig. 17)



WARNING:

At the end of the washing operations, it is compulsory to clean the recovery water tank to prevent deposits or scaling and the proliferation of bacteria, odours or mould.

- Drain the recovery water as shown in the relative paragraph, positioning the machine over a drain outlet.
- Remove the cover (6).
- Leaving the hose (12) lowered and the cap off, pour water into the tank (14) through a hose, cleaning it until clean water comes out of the drain hose.
- Clean the level probes (55) using a damp cloth, taking care not to deform them.
- Replace all the components in reverse order.

12.1.c - Cleaning the squeegee (Fig. 4)

In order to clean the squeegee correctly (11), it is necessary to remove it as follows:

- Disconnect the hose (13) from the squeegee (11).
- Loosen the knobs (32) and remove the squeegee (11).
- Wash the squeegee and in particular the rubber blades (60) and the inside of the aspiration connector (33).



NOTE:

If, during washing, it is clear that the rubber blades (60) are damaged or worn, it is necessary to replace them or turn them over.

- Replace all the components in reverse order.

OPERATIONS TO PERFORM WHEN NECESSARY

12.1.d - Cleaning the clean water filter (Fig. 18)



NOTE:

Before cleaning the filter, make sure the clean water tank is empty.

- Unscrew and remove the cover (59).
- Remove the filter (17) and wash it in running water.
- Refit the filter (17) in its seat, then tighten the cover (59).

12.1.e - Replacing the brush (Fig. 19)

It is necessary to replace the brush when it is worn more than 2 cm or it must be replaced depending on the type of floor to be washed; to replace it proceed as follows:

- Lift up the brush using the pedal as shown in the relative paragraph.
- Insert a hand under the brush holder unit (9); to release the brush, turn it abruptly in the direction of rotation.
- Replace the brush, coupling it manually to the brush holder flange (9).
- Lower the brush-holder flange (9) using the pedal, as shown in the relative paragraph.
- Press the button (45 Fig. 9) to enable the controls.
- Press the button (52 Fig. 9) to enable brush rotation.
- Adjust the sensor (20) located on the handle to start brush rotation.

12.1.f - Replacing the squeegee rubber blades (Fig. 20)

When it becomes clear that drying the floor is difficult or traces of water remain on the floor, it is necessary to check the wear on the squeegee rubber blades (60):

- Remove the squeegee unit (11) as indicated in the "Cleaning the squeegee" paragraph.
- Press the locking device (67) and open the handle (68).
- Remove the two rubber mounting strips (69) and remove the outer rubber (70).
- Loosen the two turnbuckles (71) and remove the locking bar (72) and the inside rubber (73).



NOTE:

When the rubber blades (70) or (73) are worn on one side, on one occasion they may be turned over.

- Replace or turn over the rubber blades (70) or (73) without inverting them.

- Replace all the components in reverse order.



NOTE:

It is possible to have two types of rubber blade.

Para rubber blades for all types of floor and polyurethane rubber blades for mechanical workshop floors which are dirty with oil.

12.1.g - Cleaning the recovery water tank (Fig. 21)

Remove the upper cover to access inside the recovery water tank.

- Loosen the knob (75) and remove the filter (76).
- Wash the filter (76) with running water and replace it in the machine, tightening the knob (75).

12.1.h - Replacing the fuses (Fig. 6-22)



WARNING:

Replace the blown fuse with one with the same amperage.

- Remove the plug (35) from the socket (39).
- Remove the cover (61) unscrewing the screws (62) to access the fuse.

Fuse (74) - 5A

Electronic card protection.

- Put the cover (61) back on.

Fuse (63) - 75A

Battery fuse.

- In order to replace the fuse on the positive pole of the battery, do the following:



WARNING:

Check for the recovery tank to be empty.

- Disconnect the plug (35).
- Press the button (36 Fig. 6) and lift the tank (14) until completely overturned, then replace the fuse (63 Fig. 6).

12.1.i - Wiper adjustment (Fig. 23)

- It is possible to adjust the height of the wiper and adjust the incidence of the blades on the floor.

Height adjustment**Height adjustment**

- Lower the wiper, using the lever.
- Loosen the screw (55) and lift or lower the wheel (55a) until the wiper is in the desired position, then tighten the screw (55).

Incidence adjustment

- Lower the wiper, using the lever.
- Start the aspirator and proceed for a few metres, then turn off the aspirator and stop the machine.
- Check the incidence of the rubber (60) blades.

Fig. A = too low

Fig. B = too high

Fig. C = correct position

- Use the grey knob (64) for adjustment, turning it anticlockwise to increase the incidence and in the other direction to decrease it.

12.1.I - Battery charger and digital instrument configuration (Fig. 24)**WARNING:**

The machine leaves production with a standard configuration for operation with "Sonnenschein" gel batteries.

**WARNING:**

Disconnect the battery plug from the socket.

- Remove the cover (61 Fig. 24) by unscrewing the screws (62 Fig. 24).

Standard configuration with Sonnenschein gel batteries

- Remove the cap (66) located under the batter charger (16).
- Position the switches (DP1 and DP2) as shown in figure "A".

It is possible to modify the configuration as follows:

Configuration for gel batteries which are not Sonnenschein version

- Remove the cap (66) located under the battery charger (16).
- Position the switches (DP1 and DP2) as shown in figure "B".

Configuration for acid batteries

- Remove the cap (66) located under the battery charger (16).
- Position the switches (DP1 and DP2) as shown in figure "C".

TROUBLESHOOTING

PROBLEM	CAUSE	SOLUTION
By pressing the button (45) “  ” the display does not turn on.	Low battery. Main fuse blown. The battery’s plug is still located in the charger’s outlet.	Check that the battery is charged. Replace the main 5A or 80A fuse. Place the plug correctly.
The brush does not rotate.	Function card damaged. Display card damaged. The touch sensor on the handle is defective. Brush motor damaged. Brush button not pressed.	Replace. Replace. Replace. Replace. Press the relative button.
Aspirator does not work.	Function card damaged. Display card damaged. Intake motor damaged. Aspirator button not pressed. Recovery tank full.	Replace. Replace. Replace. Press the button. Empty, wash and clean the tank and the probes.
The machine does not dry well, leaving traces of water on the floor.	Aspirator off. Aspiration tube blocked. Dirty wiper. Recovery tank full. Dirty water filter clogged. Squeegee rubber blades worn.	Start up the aspirator. Check and if necessary clean the aspiration tube that connects the squeegee to the recovery tank. Clean the wiper. Empty the recovery tank. Clean the filter. Replace or turn over the squeegee rubber blades.

PROBLEM	CAUSE	SOLUTION
No water comes out.	Tank empty. Solenoid valve enabling switch not pressed. Tap turned off. Filter blocked. Solenoid valve does not work.	Fill the tank. Press the switch. Open the tap Clean the filter. Call the technical support service.
Insufficient floor cleaning.	Unsuitable brushes or detergent. Brush worn.	Use brushes or detergents which are suitable for the type of floor or dirt to be cleaned. Replace the brush.
The brush does not rotate. Aspirator does not work. No water comes out.	Defective sensor.	Replace.

13.1 WARRANTY

During the warranty period all defective parts will be repaired or replaced, free of charge. All parts affected by tampering or misuse will be excluded from the warranty. In order to enable the warranty procedure please contact your dealer or a relevant service center by presenting the valid purchase documents.

WIRING DIAGRAM

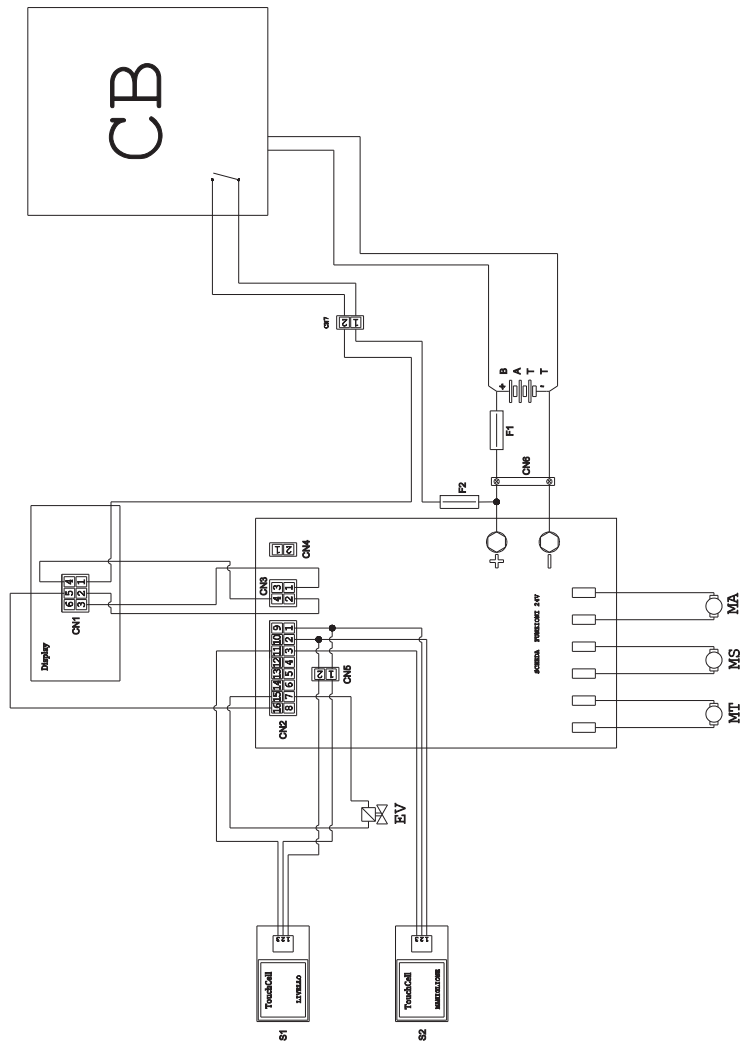

- | | | | |
|-------------------|---|-----------------|-----------------------------|
| BATT | Battery 24V | F1 | Fuse |
| CN1 | Display 6-pole connector | F2 | Fuse 5A |
| CN2 | Electronic board 16-pole connector | MA | Vacuum engine |
| CN3 | Display board 4-pole connector | MS | Brush engine |
| CN4 | Free | MT | Traction engine |
| CN5 | 2-pole flying connector,
manual touch sensor | PC | Chemical pump |
| CN6 | Battery connector | S1 | Recovery level touch sensor |
| EV | Solenoid | S2 | Touch sensor handle |
| | | | 24V function board |



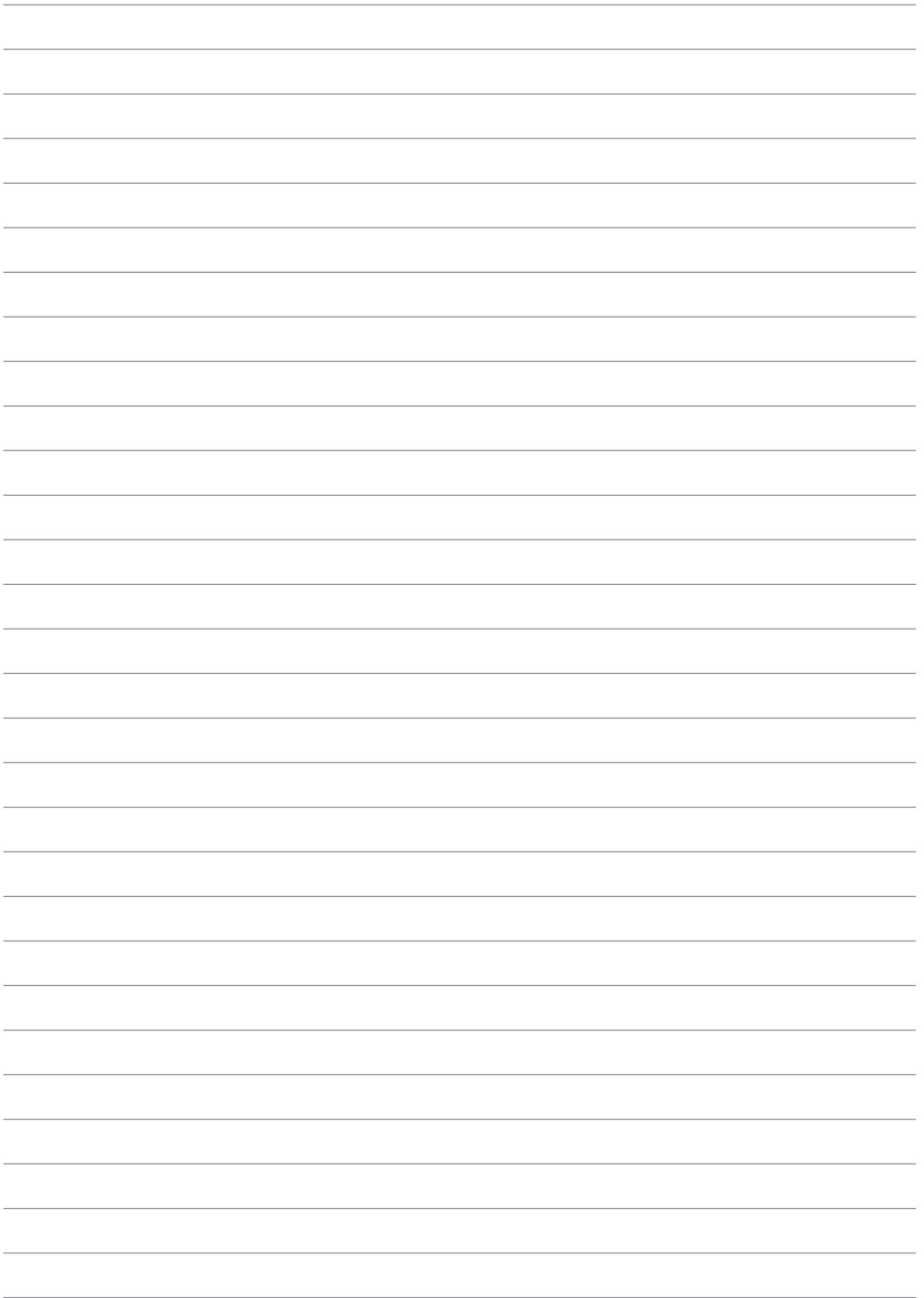

ghibli & wirbel

Professional Cleaning Machines Since 1968

DEALER

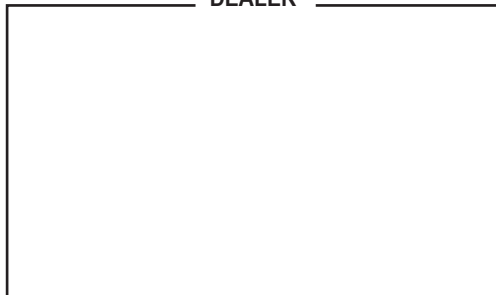

Cod. 49.0261.00 - 4^a ed. - 02/2022

Ghibli & Wirbel S.p.A.

Via Circonvallazione, 5 - 27020 Dorno PV - Italia
P. +39 0382 848811 - F. +39 0382 84668 - M. info@ghibliwirbel.com

www.ghibliwirbel.com

100% MADE IN ITALY

